

Sit-Stand.

height adjustable desking



Sit-Stand.

height adjustable desking



the benefits

leap

Single
Double
Radial & K Top

bamboo

zoom

rounde

desk converters

top options

finishes

sustainability

Plant-a-Tree Initiative

certification

Global Green Tag
WEEE



**Sit-stand
desking
encourages
a more
health-conscious
office and
supports the
wellbeing
of workers.**



Sit-Stand desking.

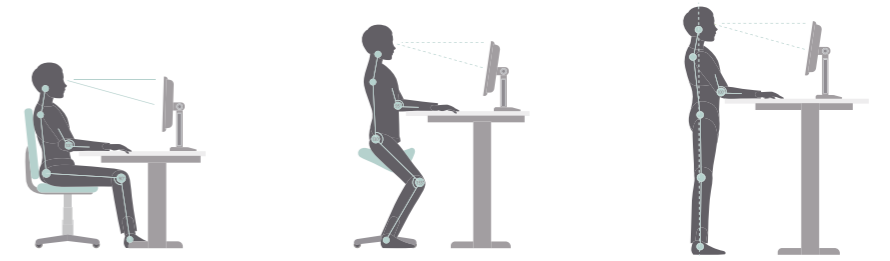

Wellbeing and ergonomics go hand-in-hand in workspaces which are people-centred and healthy.

Choosing furniture and accessories should not just be about aesthetics and price. Well-designed, properly engineered products are crucial in promoting positive employee mental and physical health which, in turn, increases productivity and presenteeism.

Our Sit-Stand Collection has been designed to enhance workplaces.

What are the benefits of sit-stand desking?

Healthier heart

People who sit for more than 8 hours a day, double their risk of developing heart disease compared to those who sit for less than 4 hours a day.

Fight obesity

Prolonged sitting slows down the metabolism, promoting fat accumulation. Standing up intermittently at a sit-stand desk decreases the risk of obesity.

Better back health

Studies show that using height-adjustable desks can dramatically decrease chronic back pain caused by inactivity and prolonged sitting.

Reduce stress & fatigue

In one seven-week study, participants using standing desks reported less stress and fatigue than those who remained seated the entire work day.

Live longer

People who sit the most are at a 49% greater risk of dying early. Reducing sitting time to 3 hours per day can raise your average life expectancy.

Improve circulation

Improve blood-flow by alternating between ergonomic office chairs that promote dynamic movement when seated and adjustable sit-stand desking.

Less stiffness

Leg and glute muscles are more active and therefore stronger, in users who alternate between sitting and standing which reduces long-term discomfort and strain.

Smarter thinking

Dynamic working encourages oxygen-rich blood to be pumped around the body, reversing the effects of inactivity where brain function slows down.

Leap sit-stand

An effortless height-adjustable desk system featuring single and back-to-back desks in a wide range of sizes, shapes and finishes.





Leap sit-stand

Leap sit-stand desks are electrically adjusted to sitting or standing height, helping to reduce the risks and problems associated with prolonged sitting.

Leap is WEEE certified and meets EN527, EN 527-1:2011 and EN 527-2:2016 including motor durability test.

Users can pair the Leap Dongle with our smartphone app to control their desk height, set memory positions, create daily standing goals, track daily standing progress and set sedentary alerts to remind them to change position.





Leap single

Use Leap's intuitive and programmable touch-sensitive controls to adjust your position from sitting to standing in seconds.

features

- Frame: white, black or silver.
- Width: 1200, 1400, 1600 and 1800 mm.
- Depth: 700 and 800 mm.
- Height-adjustable: 595 to 1245 mm.
- Intuitive touch-sensitive controls.
- Programmable memory unit.
- Optional return desk.

benefits

- Improved circulation.
- Reduces fatigue.
- Promotes productivity.
- Reduces stiffness and long term musculoskeletal discomfort.

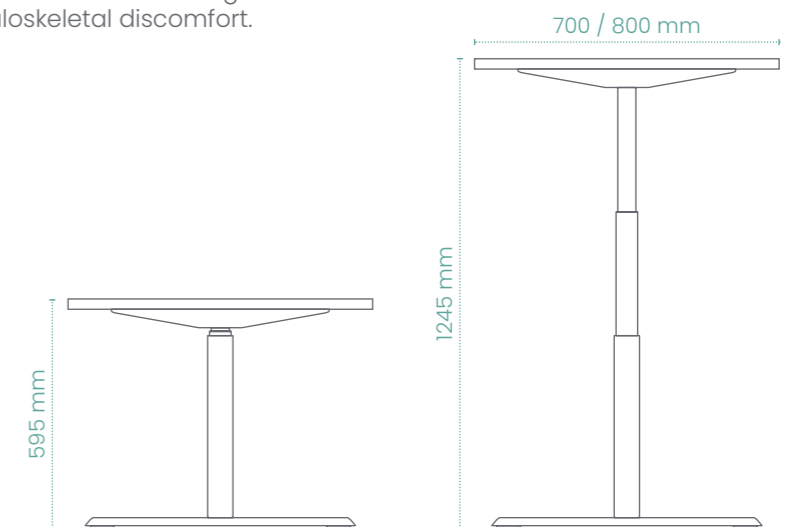



Leap double

Double the benefits, effortless adjustability and individual control in Leap's back-to-back model.

features

- Frame: white, black or silver.
- Width: 1200, 1400, 1600 and 1800 mm.
- Depth: 800 mm.
- Height-adjustable: 595 to 1245 mm.
- Intuitive touch-sensitive controls.
- Programmable memory unit.

benefits

- Compact solution for two desks.
- Improved circulation.
- Reduces fatigue.
- Promotes productivity.
- Reduces stiffness and long term musculoskeletal discomfort.

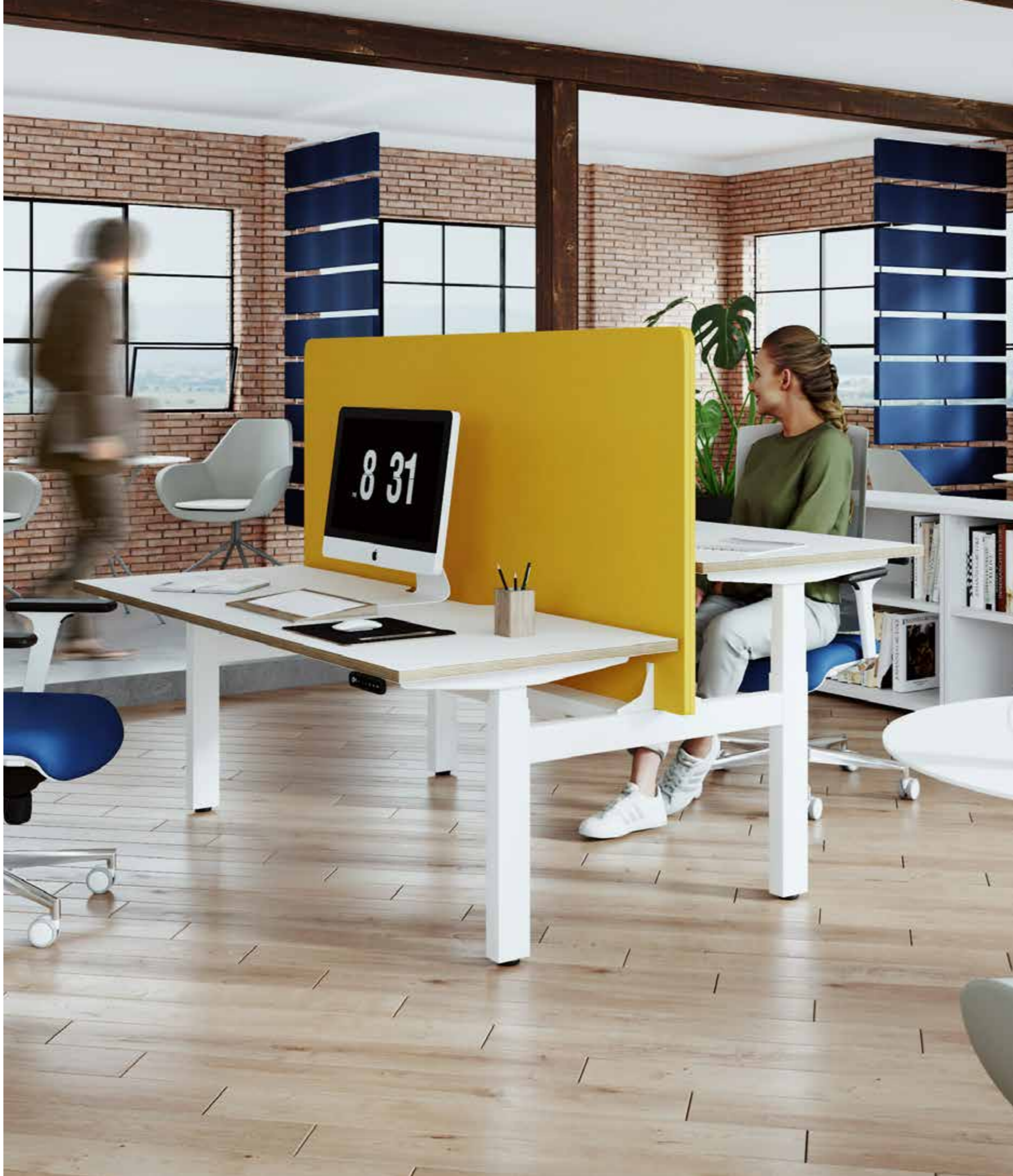
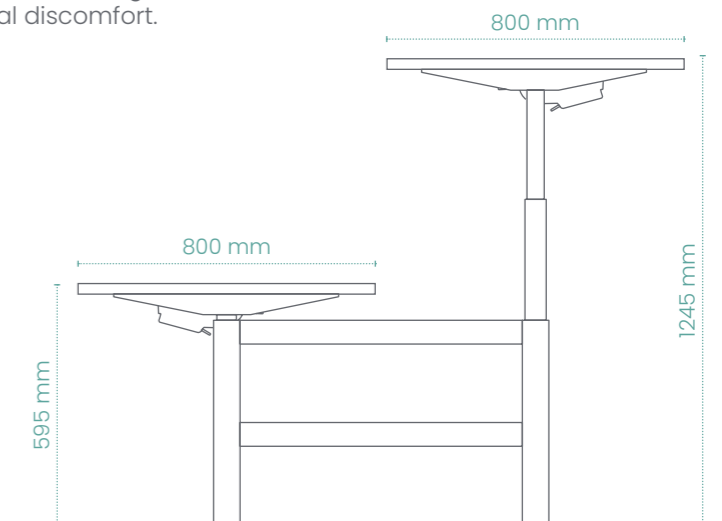



Leap radial & K

Utilise corner space in the office or create clusters of two or four workstations.

features

- Frame: white, black or silver.
- Radial Width: 1600 and 1800 mm.
- Radial Depth: 1200 mm.
- K Width: 1600 mm.
- K Depth: 800 and 1000 mm.
- Height-adjustable: 595 to 1245 mm.
- Left and right handed options.
- Intuitive touch-sensitive controls.
- Programmable memory unit.

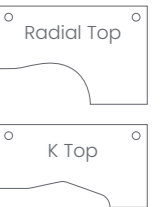

benefits

- User can stand closer to desk.
- Ideal footprint for corner spaces and clusters.
- Improved circulation.
- Reduces fatigue.
- Promotes productivity.
- Reduces stiffness and long term musculoskeletal discomfort.

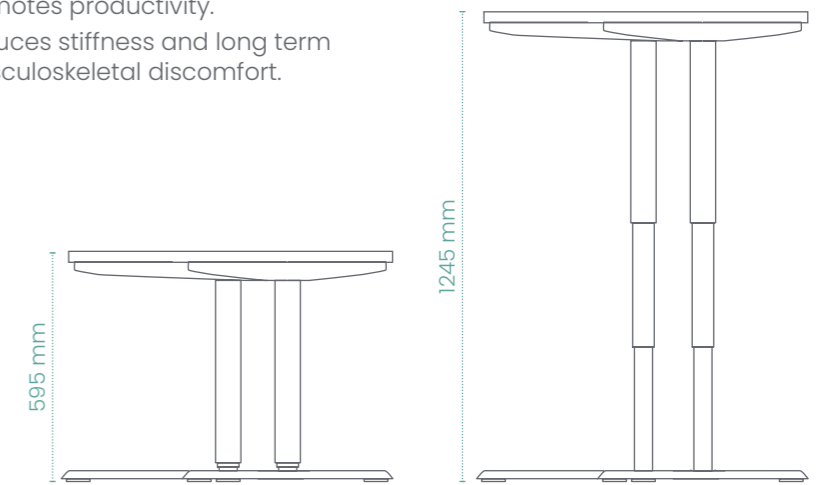



Leap options

Leap towards healthier working.

Users can pair the Leap Dongle with our smartphone app to control their desk height, set memory positions, create daily standing goals, track daily standing progress and set sedentary alerts to remind them to change position.

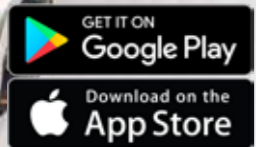
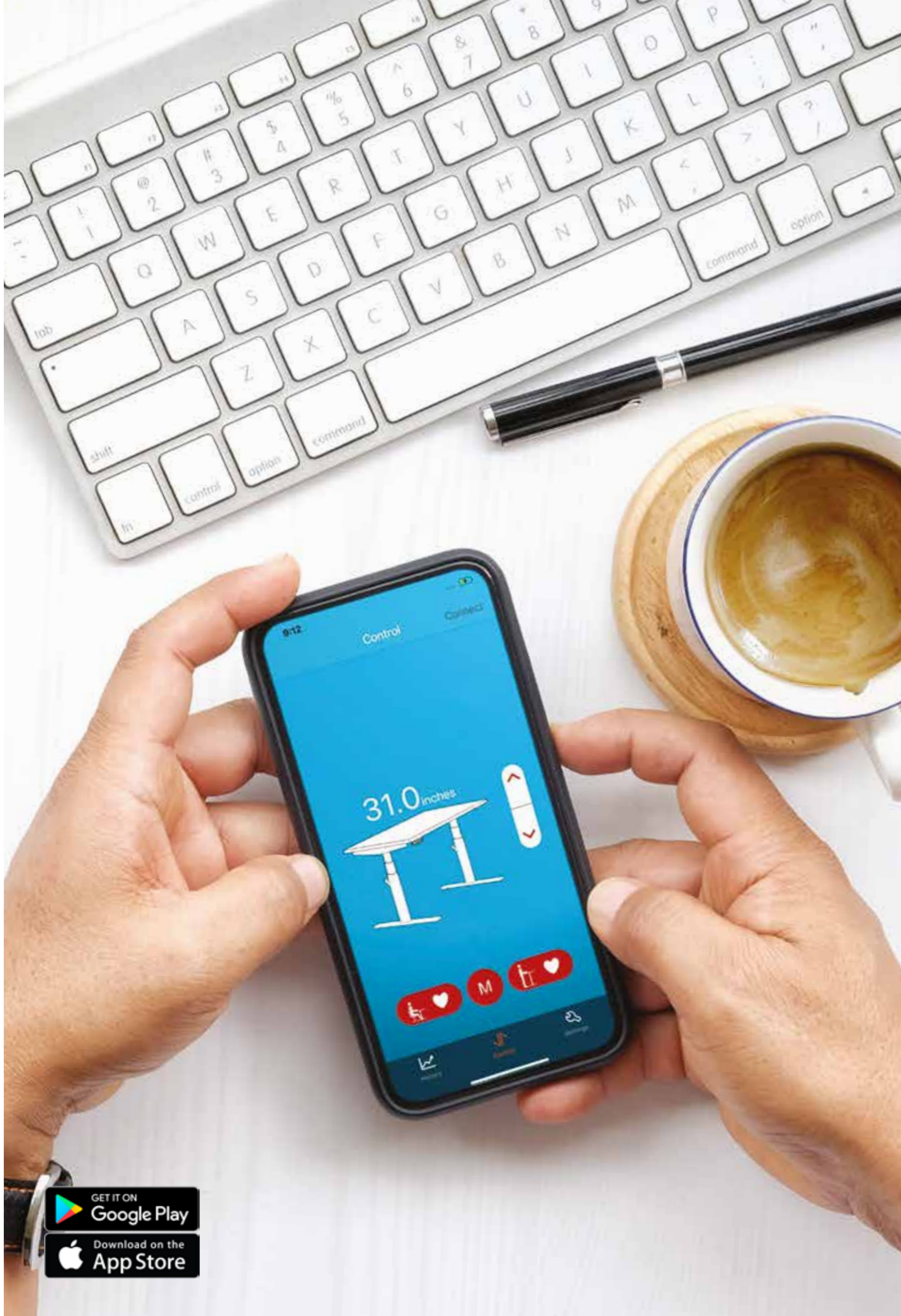

Bluetooth Dongle



Cable spine



Magnetic cable protector



Wire Cable Basket



Return desk



Side modesty panels



Plain top



Scalloped top



Portal top



Leap technical

certifications

Tested to EN527-1:2011 and EN527-2:2016 including motor durability test .

Complies with EMC Directive.

Complies with Low Voltage Directive.

Complies with RoHS Directive (Reach and PAHs).

RecoLight certified

technical specification

Speed	40 mm/s
Lifting Power	Distributed load - 125 kg
Noise	< 50 decibels
Power	220-230 V
Control Box	Control unit 2 ports voltage input 220-240 VAC 50/60 Hz
Consumption	After 10 seconds the display turns off for low consumption <0.1 W
Safety	Six-axis anti-collision software prevents accidents when the user, or an item, comes into contact with the desk.
Displays	LED displays actual desk height.
Handset	Set a minimum and maximum height. Three programmable memory positions. Lock setting. Set sensitivity and retracted height.



the most environmentally friendly sit-stand desks available.

Strong, beautiful and sustainable, Bamboo is the go-to material for eco-friendly manufacturing.

If you are conscious of how your material choices affect climate change then, naturally, bamboo tops are a great investment for your business and the planet.

Bamboo tops are available to order on our Leap, Zoom and RoundE height-adjustable desk ranges.

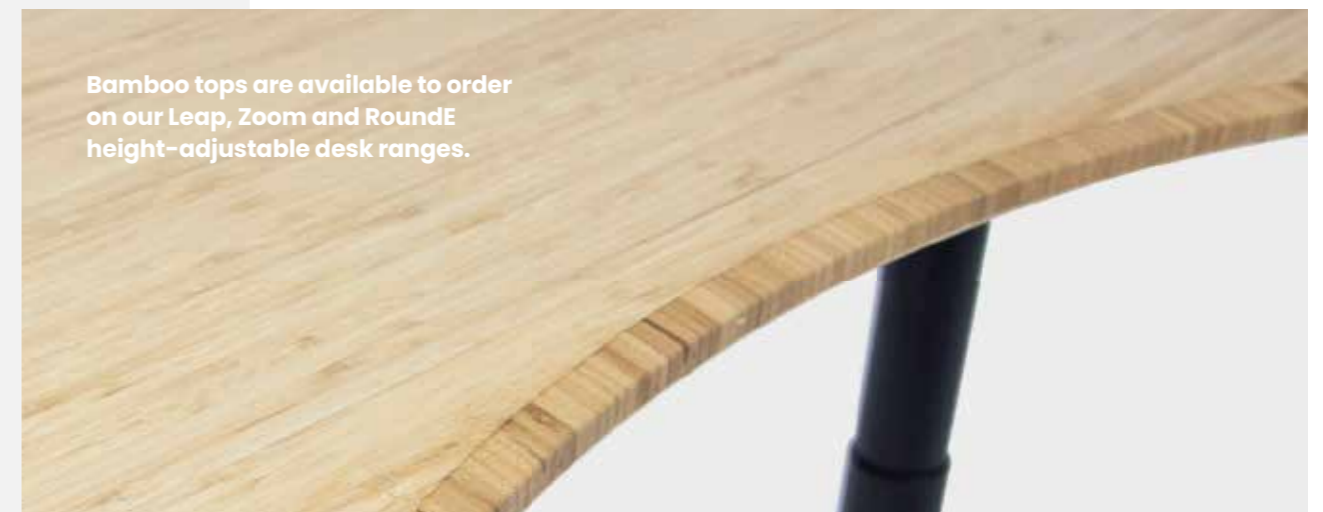

Our bamboo desktop doesn't just make a sustainable statement, it's beautiful too with unique grain striations and stunning edge detailing

Unlike our other sit-stand top options, Bamboo offers both the scallop and portal cable management options. The Bamboo desktop is both aesthetically pleasing and environmentally sound, and comes with a 10-year guarantee too.

Zoom sit-stand

With its clean lines and intuitive controls, Zoom is designed to give you the perfect ergonomic workspace, effortlessly.





Zoom sit-stand

Zoom desks can be adjusted in height by using the desk handrest which has two buttons to move the desk up and down.

features

- Frame: white, black or silver.
- Width: 1200, 1400, 1600 and 1800 mm.
- Depths: 700 and 800 mm.
- Height-adjustable: 658 to 1185 mm.
- Electric motor.
- Intuitive dual button control.
- Anti-collision software.

benefits

- Improved circulation.
- Reduces fatigue.
- Promotes productivity.
- Reduces stiffness and long term musculoskeletal discomfort.

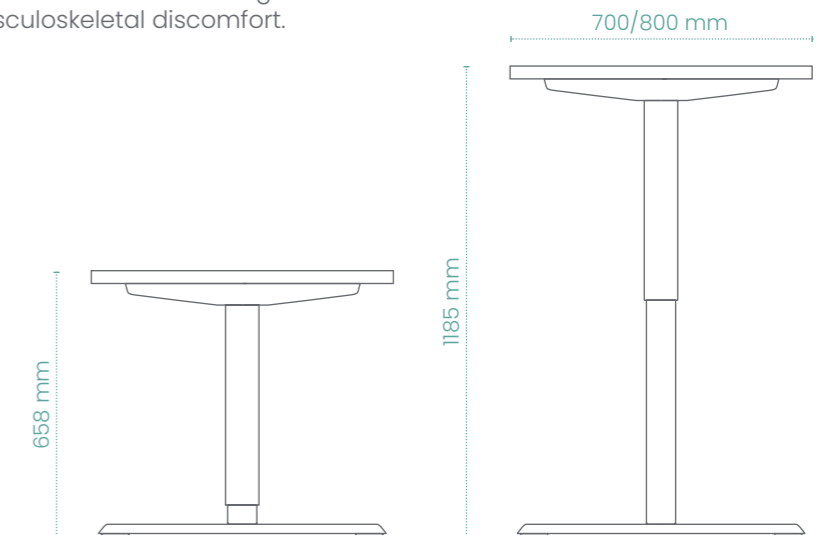

RoundE sit-stand

RoundE is a compact, space-saving solution, ideal for small or home office environments.





RoundE sit-stand

RoundE is a perfect fit for any office with its robust frame, sleek styling and low energy consumption.

features

- Frame: white, black or silver.
- Width: 1200, 1400, 1600 and 1800 mm.
- Depths: 600 and 800 mm.
- Height-adjustable: 650 to 1150 mm.
- Electric motor.
- Intuitive dual button control.
- Anti-collision software.
- LED height display.

benefits

- Improved circulation.
- Reduces fatigue.
- Promotes productivity.
- Reduces stiffness and long term musculoskeletal discomfort.

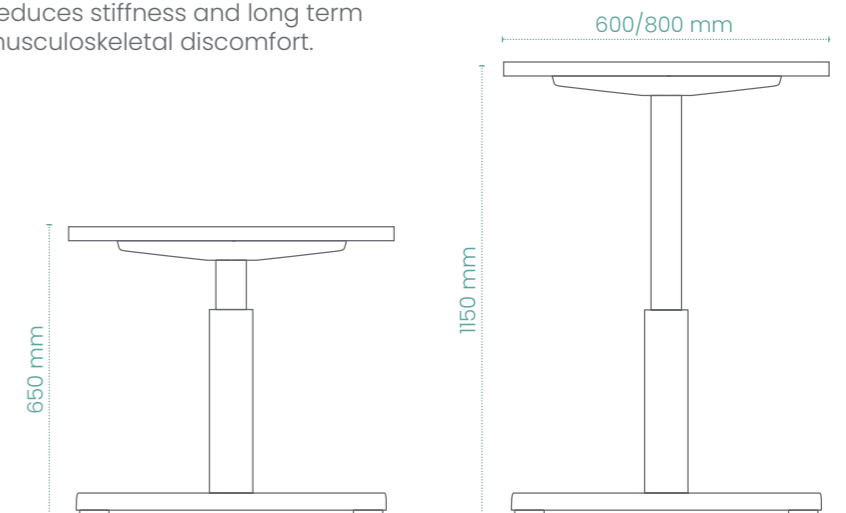

Desk converters

Instantly convert a fixed-height desk into a standing desk and get the benefits of a sit-stand lifestyle.





Desk converters

Mobile height-adjustable solutions that are perfect for home offices and workspaces where existing desking needs to be enhanced.

benefits

- Creates a height adjustable surface on existing desk.
- Reduces fatigue.
- Promotes productivity.
- Reduces stiffness and long term musculoskeletal discomfort.



Leap electric desk converter

features

- White finish.
- Designed for use by people 1500 - 2000 mm tall.
- Max load capacity 50 kgs.
- Max monitor size 25 inch .
- Electric lifting, easy operation.
- Firm base for steady lifting
- Two USB charge ports.
- Spring wire design.
- Mobile phone slot.
- Single or double monitor accessory option.



Xtend desk converter

features

- White or black finish.
- Single or double monitor models.
- Anti-collision protection.
- Firm base to ensure steady lifting.
- Lifting range: 24 - 461 mm.
- Two USB charge interfaces .

ply edge tops.

Add plywood edging to any of our height adjustable desks to add an extra design element and set your desk apart.



portal tops.

The sit stand portal top option enables users to organise and manage cables to create a tidy work surface. Users can securely feed wires through the portal to create a tidy work space.



scallop tops.

Dual scallop top allows the user to have the cut out located at the front or back of the desk. The front offers comfort for the user when sitting or standing at their desk whereas the back allows the user to organise cables.

finishes.

Did you know you can view all combinations of sizes and finishes on our website?

Our configuration tool allows users to change product attributes such as colours, fabrics, size and more. Users can also create a PDF with product content.

Alternative specifications.

We often can supply alternative sizes, colours and finishes that we can manufacture to order. These may take a little longer to get to you, but they'll always be worth the wait.

Contact our customer services team for more information.

Stocked MFC finishes

18 and 25 mm MFC

White

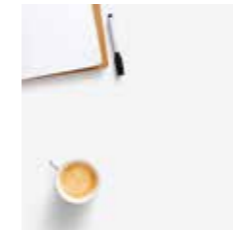

Harbour Oak

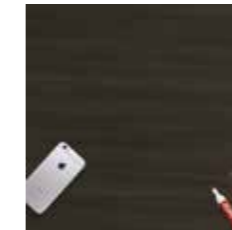

Urban Oak



Graphite

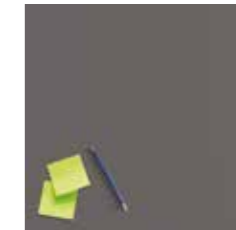

Made to order MFC finishes

18 and 25 mm MFC

Beech



Dark Walnut

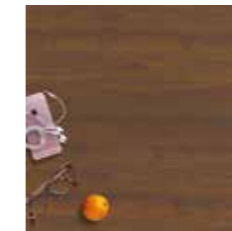

Grey



Arctic Oak



Bamboo ^{*Sustainable*}



Maple



Ply edge White/Graphite



Due to printing limitations, we cannot guarantee an exact colour match to this brochure. We recommend you request a swatch prior to order.

for every desk we sell, we will plant a tree.

RESTORE
NATIVE
FOREST

PROMOTE
ACCESS TO
MEDICINAL
AND OTHER
FORESTRY
PRODUCTS

INCREASE
FOOD
SECURITY

CREATE
ACCESS TO
CLEAN WATER



Sustainability

We partner with the Global Climate Institute, where we plant a tree in Tanzania for every desk sold.



Why Tanzania?

The deforestation rate in Tanzania is amongst the highest in East Africa. For a country where the forests typically help fuel the national economy, this degradation has a dramatic impact on rural communities, causing major food insecurity.

Luckily, tree planting proves to be one of the most versatile and cost effective means to improve the quality of life for people living in impoverished areas, as the trees will provide decades of food, medicine, shade, firewood, carbon fixation, environmental enhancements, wildlife habitat and benefit the global climate.



Certification



Our sit-stand desk frames are now Global Green Tag certified.



LEAP SINGLE



LEAP BENCH



ZOOM



ROUND-E

Global Green Tag is one of the world's most robust, trusted and widely recognised ecolabels. The globally trusted certification standards are recognised worldwide.

Global GreenTag independently assures that every product is fitness tested and certified under one of their two leading certification programs that use the world's best scientific methods. That's why they have earned the reputation and trust of thousands of buyers, hundreds of companies and numerous green building councils, certification bodies and governments around the world.

Reuse and recycling of Waste Electrical and Electronic Equipment.

Edit Office is WEEE certified for all sit-stand desks.

Leap products are WEEE certified (Waste Electrical and Electronic Equipment). WEEE Ireland is a not for profit organisation, committed to delivering cost effective compliance since 2005. WEEE Ireland represents 74% of the electrical and electronic industry who have a Producer responsibility under the WEEE Directive 2012/19/ EU to organise and finance the environmental management of their products at their end of life.

Any electrical goods you purchase from us we will recycle for free at the end of their life cycle. By being WEEE registered we can help make an environmental difference by:

- Reducing the amount of waste going to landfill.
- Save the planet by reducing the effects of the hazardous materials in WEEE.
- Conserve natural resources as materials such as plastics, glass and metals are recovered for use again in the industry.

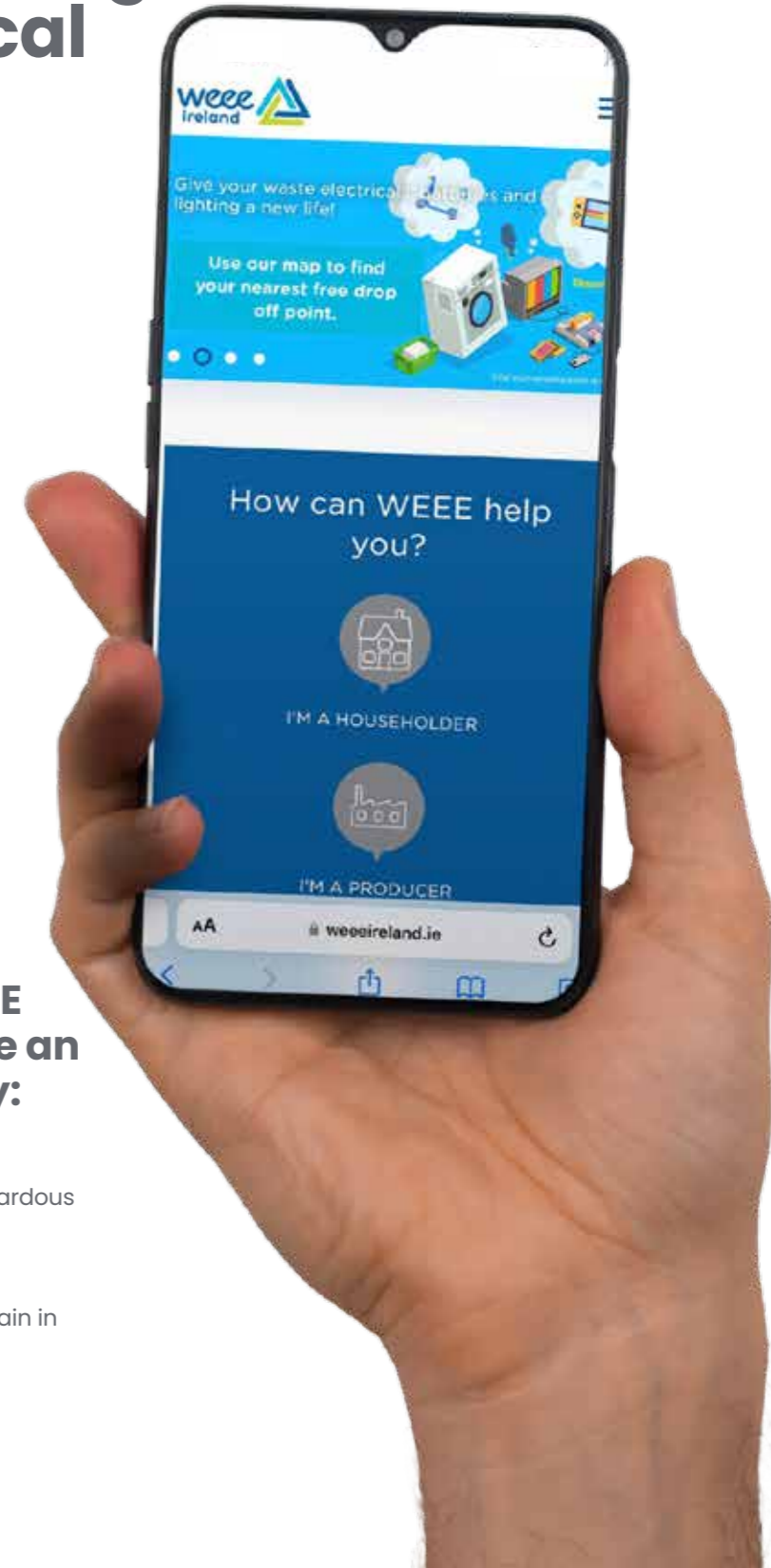



G1 Centrepont, Rosemount Business Park
Ballycoolin, Dublin 11. 01-5540101
interiors@igate.ie www.igateinteriors.ie