



# SWITCH

Highly Flexible Desking

**iGate**  
Interiors.ie

Switch is a highly flexible desking range with the ability to make complex single structure configurations of any length. Five sub systems comprising of various shapes interact together to give you the most versatile desking system we have ever designed.

Switch has been laboratory test certified by Satra and has passed the following tests:

BS EN 527-1:2011 – Ergonomics  
BS EN 527-2:2002 – Mechanical Safety  
BS EN 527-3:2003 – Strength and Stability.

Oh and it comes with a 20 year guarantee.

# Contents

Bench	3 - 12
Design	13 - 18
120 Degree	19 - 26
Crescent	27 - 34
Straight	35 - 42
Meeting	43 - 50
Accessories	53 - 56



# Bench

# Overview



Create workstations of any length. Available in 3 top depths, 3 leg finishes, 6 widths, 8 panel colours, 4 metal paint finishes making 2,052 combinations for each line.

4 Person (2000 x 800mm per top) A-frame leg bench with heavy duty cable tray. White metal frame.







# Bench Ranges

Bench Desks are available in 3 depths of top, 600mm, 700mm and 800mm and 6 widths from 1,000mm to 2,000mm.



2 Person Bench A-Leg



2 Person Bench Open-Leg



2 Person Bench Closed-Leg



4 Person Bench A-Leg



4 Person Bench Open-Leg



4 Person Bench Closed-Leg



6 Person Bench A-Leg



6 Person Bench Open-Leg



6 Person Bench Closed-Leg



8 Person Bench A-Leg



8 Person Bench Open-Leg



8 Person Bench Closed-Leg



Switch 2 Person Bench Desk, Light Beech finish & desk high pedestal. White open leg frame.







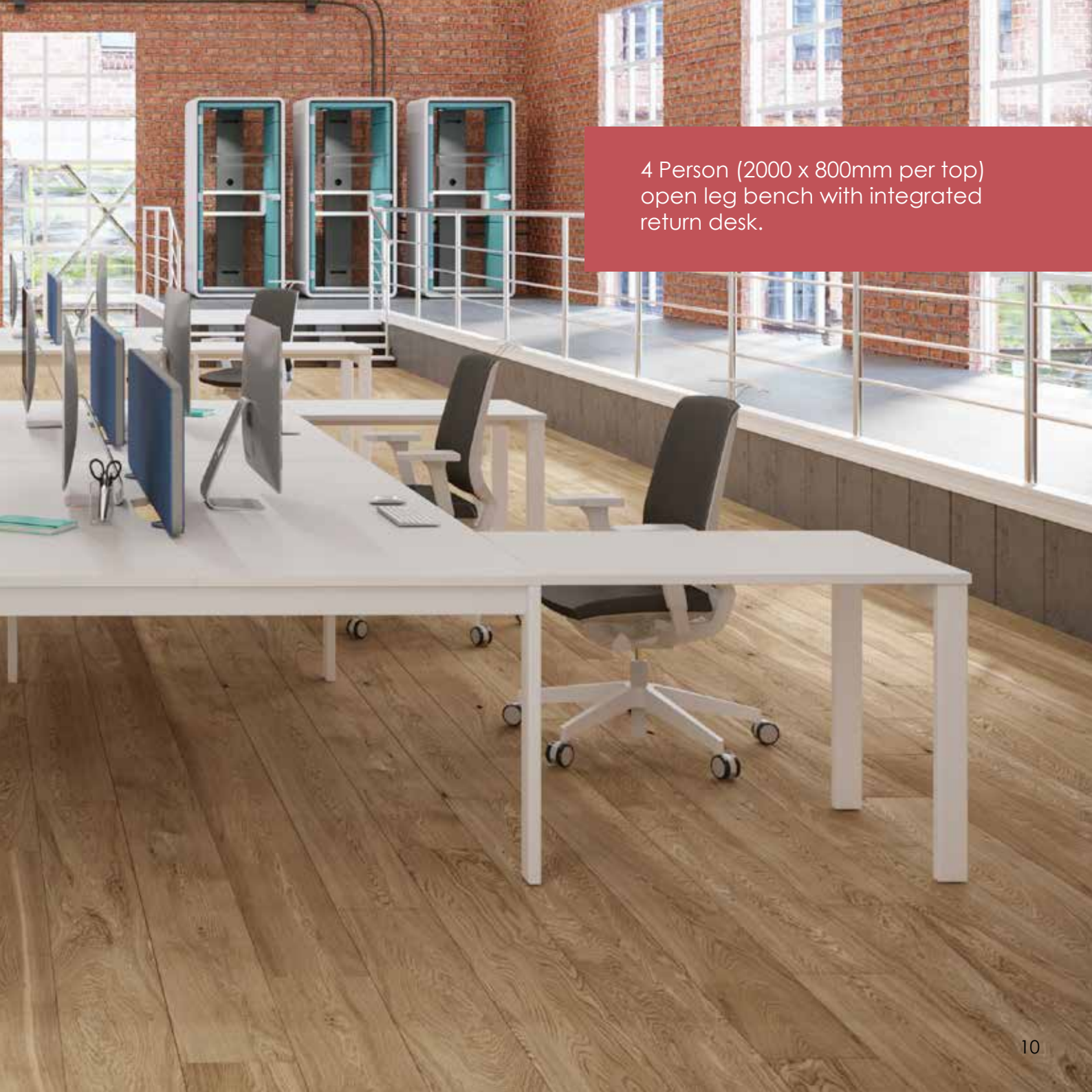

4 Person (2000 x 800mm per top)  
open leg bench with integrated  
return desk.

Open leg bench wave desk with Arctic Oak finish and White metal frame.







# SWICTH DESIGN

## Overview



Switch Design is a highly flexible desking range with the ability to make complex single structure configurations of any length. The stylish desk comes with a natural oak wooden leg and a spacious desk surface.





Switch Design 2 person bench desk with white top and scallops. Includes LightUp chairs and Packman soft seating.



# SWITCH DESIGN Ranges

Switch Design desks are available in 800mm depth and widths of 1000mm, 1200mm, 1400mm, 1600mm, 1800mm and 2000mm. Tops are available in the standard wood panel colours.

Switch Design Single Desk

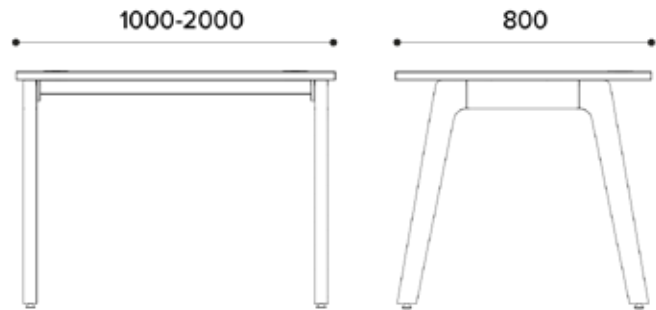

Switch Design Bench Desk

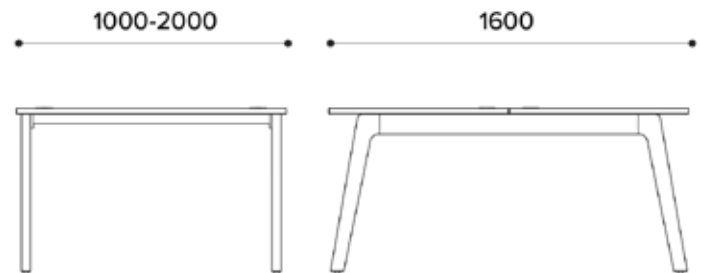



# 120 Degree

# Overview





120 degree workstations can be inter connected with straight bench desking using a special shared leg to make complex configurations.







120 Degree 3 Person Workstation 1200mm, open leg. White panel and Black metal work.

# 120 Degree Ranges



3 Person Bench 1200mm  
A-Leg



3 Person Bench 1200mm  
Open-Leg



3 Person Bench 1200mm  
Closed-Leg



3 Person Bench 1600mm  
A-Leg



3 Person Bench 1600mm  
Open-Leg



3 Person Bench 1600mm  
Closed-Leg



120 Degree 3 Person Workstation, 1600mm closed leg. White panel and Black metal work.







120 Degree 3 Person Bench, A-Leg. Urban Oak panel and Silver metal work.



# Crescent

# Overview





The classic crescent desk shape can be used on its own or in groups of 2 and 4. Crescent desks are available in 2 widths, 1600mm and 1800mm.





Crescent Desk Right & Left Hand 1800 x 1200mm  
A-Leg with desk high pedestal. White panel and  
Black metal work.



# Crescent Ranges

Bench Desks are available in 1600mm & 1800mm widths.



Crescent A-Leg & Desk  
High Pedestals



2 Person Crescent A-Leg  
& Desk High Pedestals



Crescent Open-Leg &  
Desk High Pedestals



2 Person Crescent Open-Leg  
& Desk High Pedestals



Crescent Closed-Leg &  
Desk High Pedestals



2 Person Crescent Closed-Leg  
& Desk High Pedestals





2 Person Crescent Workstation 3200 x 1600mm  
& desk high pedestals, closed leg. White panel  
and Silver metal work.



Crescent Desk Right & Left Hand 1800 x 1200mm  
Closed Leg with desk high pedestal. Urban Oak panel  
and White metal work.





**Straight**

Overview





Straight Desks are available in 3 depths of top, 600mm, 700mm and 800mm and 6 widths from 1000mm to 2000mm. A-Frame not available on 600mm deep tops.

Perfect for single manager and executive offices as well as open plan individual desking arrangements. Dark Walnut and Black leg finish.





# Straight Ranges

Straight Desks are available in 3 depths of top, 600mm, 700mm and 800mm and 6 widths from 1,000mm to 2,000mm. The A-Frame is not available on 600mm deep tops.



Straight A-Leg



Straight Open-Leg



Straight Closed-Leg



Single Desk Add-On Unit



Return Desk, Open Leg



Return Desk, Closed Leg



Straight 2000 x 800mm workstation with  
modesty panel, A-Leg. Arctic Oak panel  
and White metal work.



Straight 2000 x 800mm workstation with modesty panel & connected return desk (1000 x 600mm), closed leg. Carbon Walnut panel and White metal work.





# Meeting

# Overview





Create tables of any length. Available in square, rectangular & oval shapes & comprising of 3 leg types, 2 top depths, 6 top widths which can be further interconnected, 8 panel colours & 4 metal paint finishes makes for an endless array of combinations.

Switch Two Piece Curved Meeting Table,  
Open Leg with Maple panel and White  
metal finish.







# Meeting Ranges

## Curved

Pictured with A-Frame legs but available in A-Frame, Open & Closed leg options to match desking ranges.



Meeting Table  
2000x1000/800 A-Leg



Meeting Table  
2500x1200/1000 A-Leg



Meeting Table  
3000x1200/1000 A-Leg



Meeting Table  
Centre Extension\* for  
3000x1200/1000 Table



Meeting Table  
4000x1400/1200 A-Leg



Meeting Table  
Centre Extension\* for  
4000x1400/1200 Table

## Straight



Single Piece Square  
Meeting Table 1200 or  
1400mm



Rectangular Table  
1200mm or 1400mm deep



Rectangular Meeting  
Table extension\*

\*Available in 6 widths 1,000 to 2,000mm



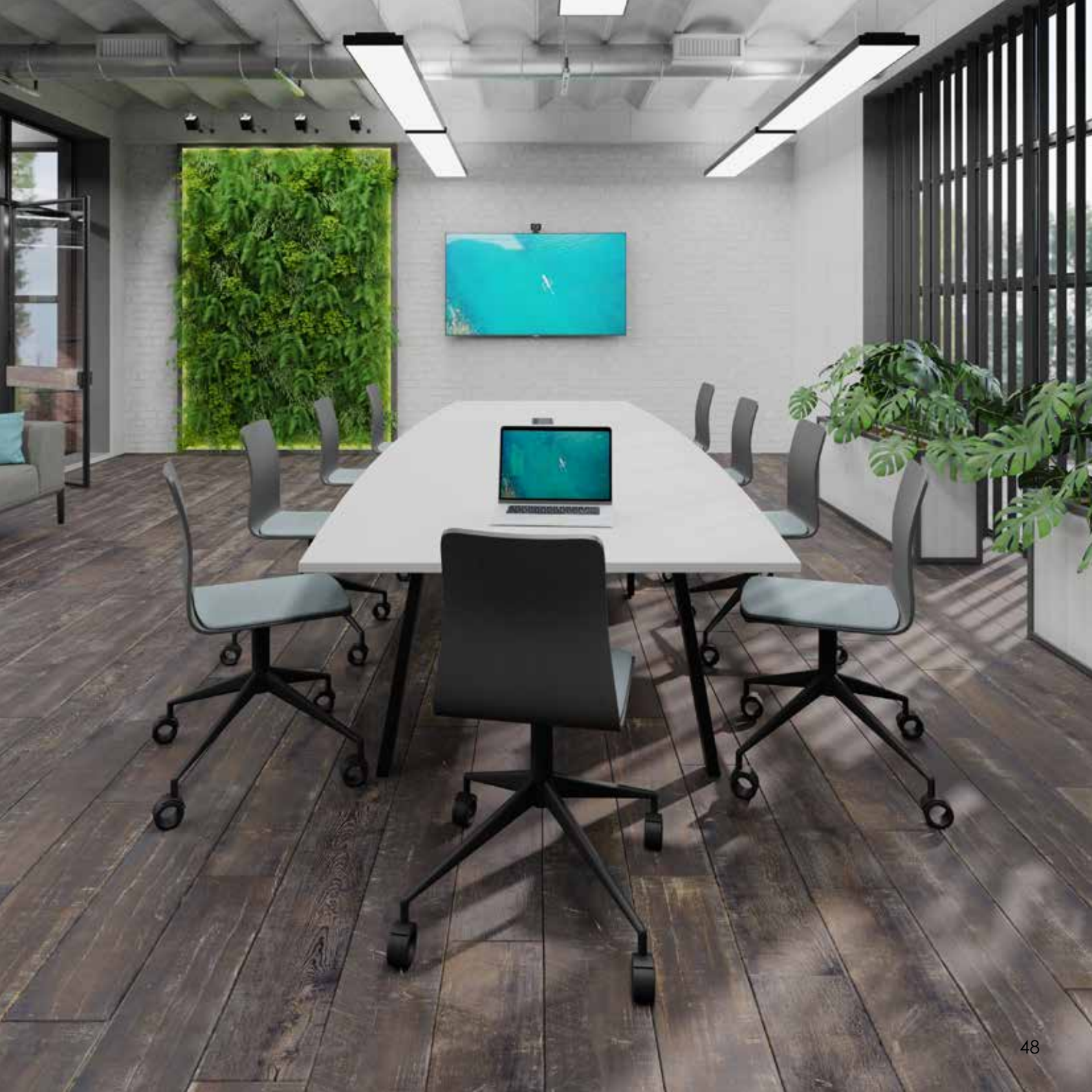







Switch Two Piece Curved Meeting Table, A-Leg with White panel and Black metal finish. Ellie Pro chairs.

# SWITCH Assembly Explanation

**Our 4 step guide**  
configure workstations  
of **any length**

## Stage 1

Remove the end leg (shown in red) from  
the 2 person workstation.



---

## Stage 2

Take as many shared leg add-on workstations  
that you require.





## Stage 3

Place the end leg from the 2 man workstation onto the end of the last shared leg add-on workstation.



## Stage 4

The finished 4 man workstation.



## Leg Options

Closed Leg



Open Leg



A-Leg



**SWITCH**

Accessories



Top options, cable management options and available panel colours.

# Top Options

**Available Top Types:** Plain, Portals or Scallops.



Plain Top



Top with Portals



Top with Scallop

# Cable Management Options



Wire Basket



Cable Spine

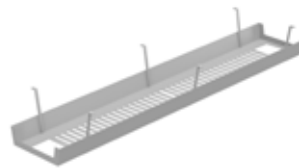

Heavy Duty Tray



Cable Housing



# Colourways Panel

All the following materials are E1 Grade, impact and scratch resistant MFC.

## Standard Colours



Arctic Oak (AO)



Urban Oak (UO)



Maple (MP)



Beech (BE)



Dark Walnut (DW)



Harbour Oak (HO)

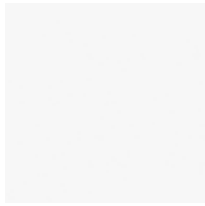

White (WH)



Grey (GY)

## Frame Colours

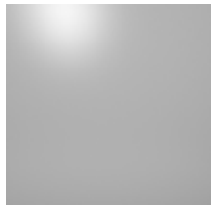

Silver (SLV)

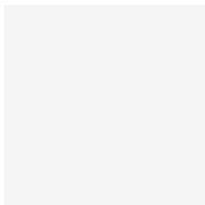

White (WHT)

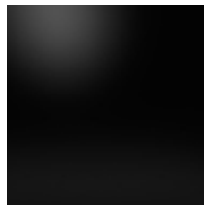

Black (BLK)

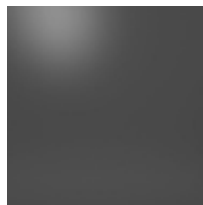

Anthracite (ANC)



Raw Steel (RAW)

All paint used is completely solvent-free and offers up to 99% material utilisation. Consequently, this coating method is incredibly economical and, at the same time, eco-efficient.







G1 Centrepoint, Rosemount Business Park  
Ballycoolin, Dublin 11. 01-5540101  
interiors@igate.ie www.igateinteriors.ie

**SWITCH**